



## 2.3 Check the door and lock function

1) After door is installed, the lock can be opened and closed freely, and the door can be closed with a little force, and the central lock tongue can be easily engaged with **the centre striker plate**.

2) Rotate the handle, the top and bottom dead bolts can move up and down smoothly in the strikers. The force to rotate the handle is appropriate. Easy to unlock/lock with the key and Deadlock catch. And the key can turn back to original position automatically.

3) Rotate the release lever, the outer door and the Security door can be automatically **separated**. If the release lever is not rotated, the security door and the outer door must not be separated. the outer door and the security door can be **joined easily**. See the Operation instruction for details.

Notice:

1)The handle and key must be rotated into place.

2)The lock is debugged before leaving the factory. If the dead bolt does not smoothly engaged with the striker as Fig. 7, the striker can be adjusted up and down as Fig. 8.

If the force of rotating the handle is too big or if the door is not closed tightly, the striker can be adjusted back and forth as in Fig. 9.

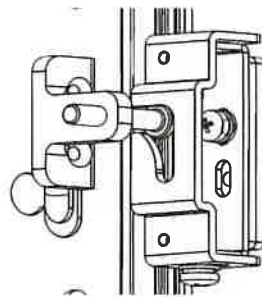

Fig. 7

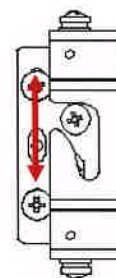
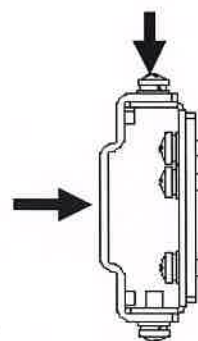
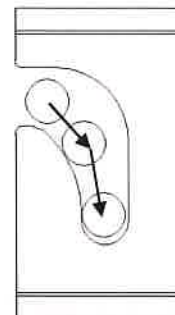

Fig. 9

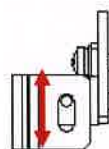

Fig. 8

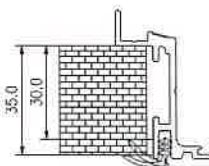

Fig. 10



# AUSSIE TRAVELLER

Incorporated in Queensland A.C.N. 010 809 168 A.B.N. 81 010 809 168

## 2.4 Fix rubber trim

- 1) When the wall thickness is 30-35mm, use rubber trim (MD-XJT-002) as in Fig. 10.
- 2) When the wall thickness is 25-29mm or 36-40mm, use rubber trim (MD-XJT-004). as in Fig. 11.

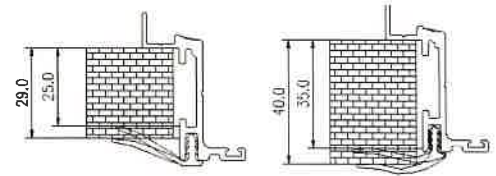

Fig. 11

### Note:

- 1) It is necessary to tighten the rubber trim to prevent wrinkling.
- 2) The rubber trim at the strikers needs to be cut off.
- 3) The rubber trim joints should be glued.
- 4) If the rubber trim warps at corners, glue or double-sided tape can be used.

2.5 Fix striker back brace with M5X12 as Fig. 12.

2.6 fix striker plastic cover as Fig. 13.

2.7 install the "D" shaped door holder to the wall of the caravan.

2.8 Please eliminate all glue material around the door.

### Notice:

1. The door can not be used before it is fixed firmly.
2. During travel, ensure that the door is in a lock state.
3. Do not rotate the handle freely when the door is open. If you do that, the dead bolt will hit the striker when closing the door.

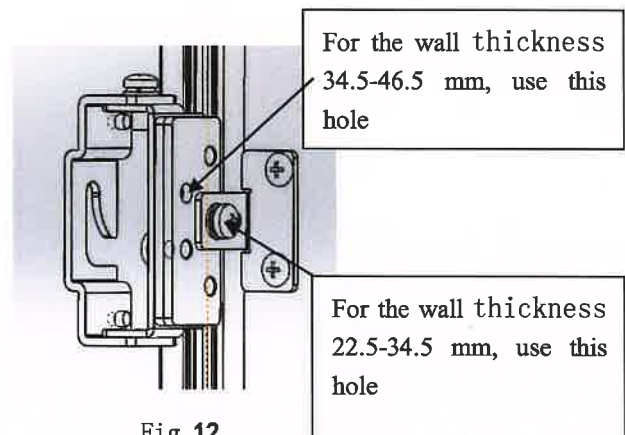

Fig. 12

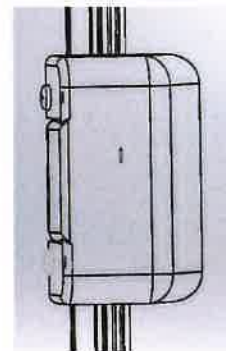

Fig. 13

- **NEVER TRAVEL WITHOUT THE DOOR BEING LOCKED \***